

Technical Data Sheet

Photocoupler

EL817 Series

Features:

- Current transfer ratio
(CTR:MIN.50% at IF =5mA ,VCE =5V)
- High isolation voltage between input and output (Viso=5000 V rms)
- Compact dual-in-line package
EL817*:1-channel type
- Pb free

- UL approved (No. E214129)
- VDE approved (No. 132249)
- SEMKO approved (No. 0143133/01-03)
- NEMKO approved (No. P00102385)
- DEMKO approved (No. 310352-04)
- FIMKO approved (No. FI 16763A2)
- CSA approved (No. 1143601)
- BSI approved (No. 8592 / 8593)

- Options available:
 - Leads with 0.4"(10.16mm) spacing (M Type)
 - Leads bends for surface mounting (S Type)
 - Tape and Reel of Type I for SMD(Add"-TA" Suffix)
 - Tape and Reel of Type II for SMD(Add"-TB" Suffix)
 - The tape is 16mm and is wound on a 33cm reel

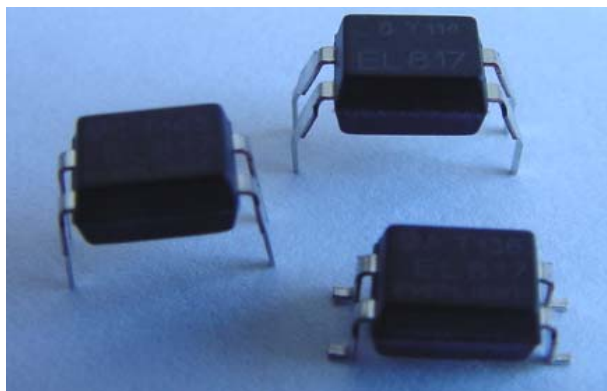

Description

The EL817 series contains an infrared emitting diode optically coupled to a phototransistor. It is packaged in a 4-pin DIP package and available in wide-lead spacing and SMD option.

Applications

- Computer terminals
- System appliances, measuring instruments
- Registers, copiers, automatic vending machines
- Cassette type recorder
- Electric home appliances, such as fan heaters, etc.
- Signal transmission between circuits of different potentials and impedances

**Technical Data Sheet
Photocoupler**
EL817 Series
Device Selection Guide

Part. No.	Chip Material	
	IR	PT
EL817*	GaAs	Silicon

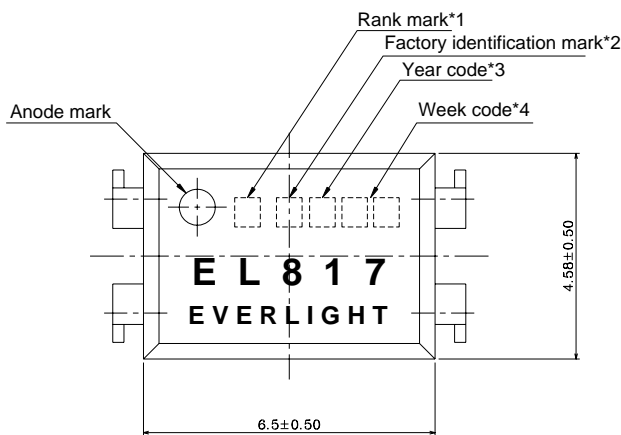
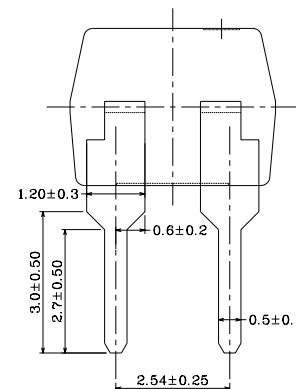
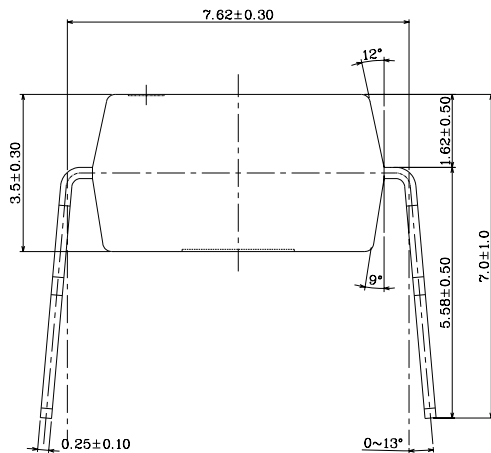
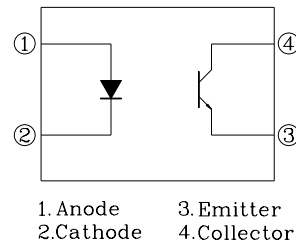
Package Dimensions

PIN NO. AND INTERNAL CONNECTION DIAGRAM

Technical Data Sheet
Photocoupler

EL817 Series

Package Dimensions

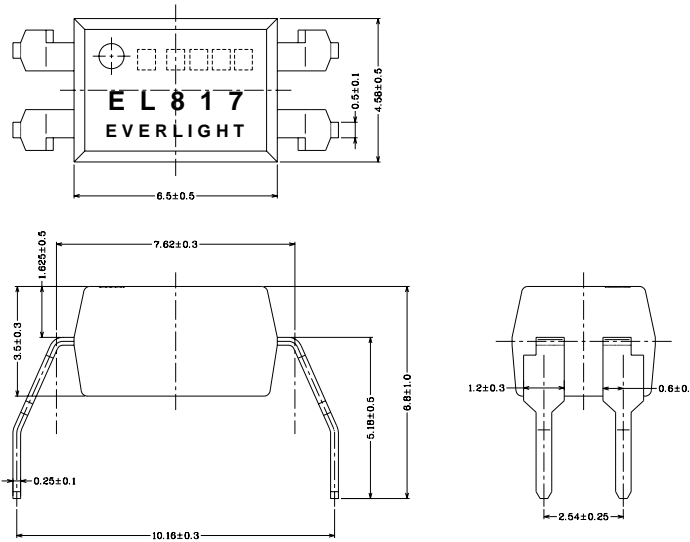
M Type



S Type

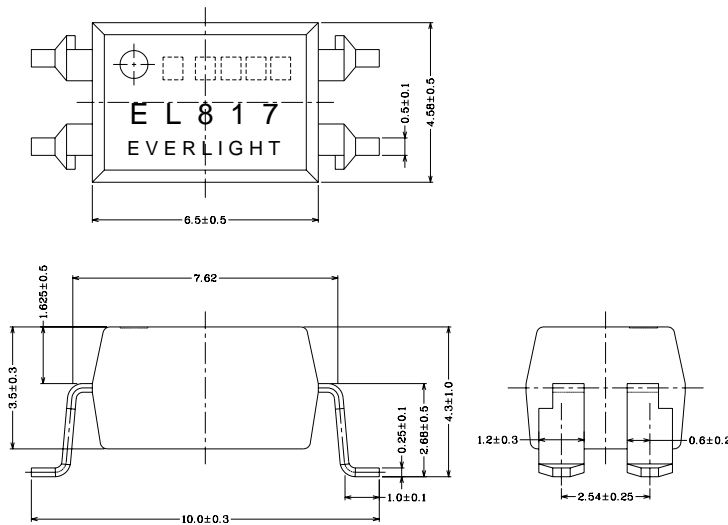

Notes:

1. Rank shall be or shall not be marked
2. Factory code shall be marked (T: Taiwan / C: China)
3. Year date code
4. 2-digit work week
5. All dimensions are in millimeters
6. Specifications are subject to change without notice

**Technical Data Sheet
Photocoupler**
EL817 Series
Absolute Maximum Ratings (Ta=25°C)

Parameter		Symbol	Rating	Unit
Input	Forward Current	I_F	50	mA
	Reverse Voltage	V_R	6	V
	Power Dissipation	P	70	mW
Output	Collector Power Dissipation	P_C	150	mW
	Collector Current	I_C	50	mA
	Collector-Emitter Voltage	V_{CEO}	35	V
	Emitter-Collector Voltage	V_{ECO}	6	V
Total Power Dissipation		P_{tot}	200	mW
*1 Isolation Voltage		Viso	5000	V rms
Operating Temperature		Topr	-55~+110	°C
Storage Temperature		Tstg	-55~+125	°C
*2 Soldering Temperature		Tsol	260	°C

*1 AC for 1 minute, R.H= 40~ 60%RH

-Isolation voltage shall be measured using the following method.

- (1) Short between anode and cathode on the primary side and between collector, emitter and base on the secondary side.
- (2) The isolation voltage tester with zero-cross circuit shall be used.
- (3) The waveform of applied voltage shall be a sine wave

*2 For 10 seconds

**Technical Data Sheet
Photocoupler**
EL817 Series
Electro-Optical Characteristics

(Ta=25°C)

Parameter		Symbol	Min.	Typ.	Max.	Unit	Condition
Input	Forward	V_F	-	1.2	1.4	V	$I_F=20\text{mA}$
	Reverse Current	I_R	-	-	10	μA	$V_R=4\text{V}$
	Terminal	C_t	-	30	250	pF	$V=0, f=1\text{kHz}$
Output	Collector Dark current	I_{CEO}	-	-	100	nA	$V_{CE}=20\text{V}$
	Collector-Emitter breakdown voltage	BV_{CEO}	35	-	-	V	$I_C=0.1\text{mA}$
Transfer Characteristics	Current Transfer ratio	CTR	50	-	600	%	$I_F=5\text{mA}, V_{CE}=5\text{V}$
	Collector-Emitter saturation voltage	$V_{CE(sat)}$	-	0.1	0.2	V	$I_F=20\text{mA}, I_C=1\text{mA}$
	Isolation resistance	R_{ISO}	5×10^{10}	10^{11}	-	Ω	DC500V, 40~60%R.H
	Floating capacitance	C_f	-	0.6	1.0	pF	$V=0, f=1\text{MHz}$
	Cut-off frequency	f_c	-	80	-	kHz	$V_{CE}=5\text{V}, I_C=2\text{mA}$ $R_L=100\Omega, -3\text{dB}$
	Rise time	t_r	-	4	18	μs	$V_{CE}=2\text{V}$ $I_C=2\text{mA}, R_L=100\Omega$
	Fall time	t_f	-	3	18	μs	

**Technical Data Sheet
Photocoupler**
EL817 Series
Supplement
Current Transfer Ratio CTR

Sub-Model No.	Rank mark	CTR (%)	Condition
EL817* ^{note 1}		50 to 600	$I_F = 5 \text{ mA}$ $V_{CE} = 5 \text{ V}$ $T_a = 25^\circ\text{C}$
EL817* (L) ^{note2}	L	50 to 100	
EL817* (A)	A	80 to 160	
EL817* (B)	B	130 to 260	
EL817* (C)	C	200 to 400	
EL817* (D)	D	300 to 600	
EL817* (AB)	A or B	80 to 260	
EL817* (BC)	B or C	130 to 400	
EL817* (CD)	C or D	200 to 600	

Note1. The symbol “ * ” can be none or S or M by different leads form request

Note2. The symbol “ () ” can be CTR rank

Fig. 1 Forward Current vs.
Ambient Temperature

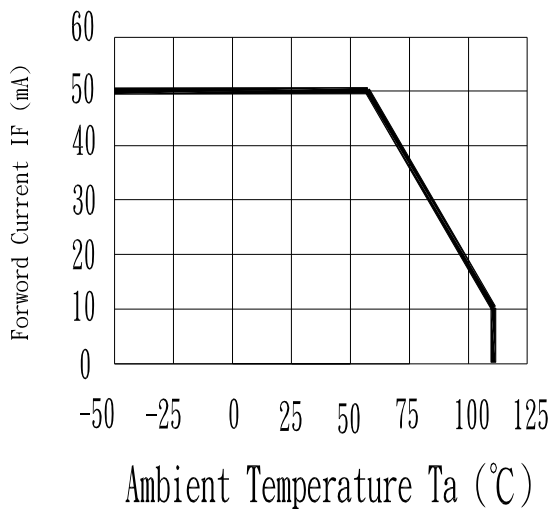
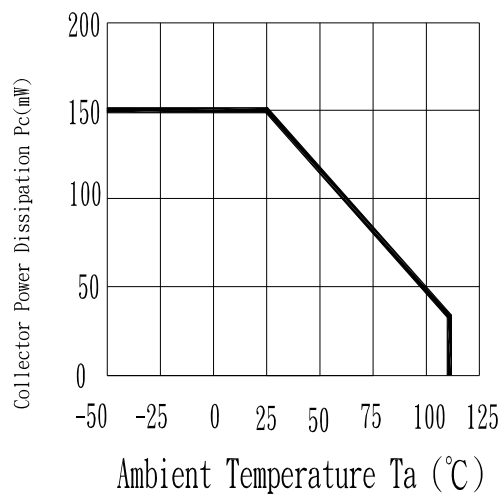

Fig.2 Collector Power Dissipation vs.
Ambient Temperature



Technical Data Sheet
Photocoupler

EL817 Series

Fig.12

Collector-emitter Saturation Voltage vs. Forward Current (Ta=25°C)

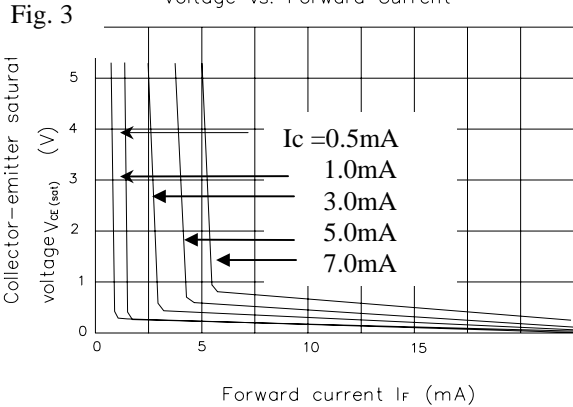

Fig.4

Current transfer Ratio vs. Forward Current

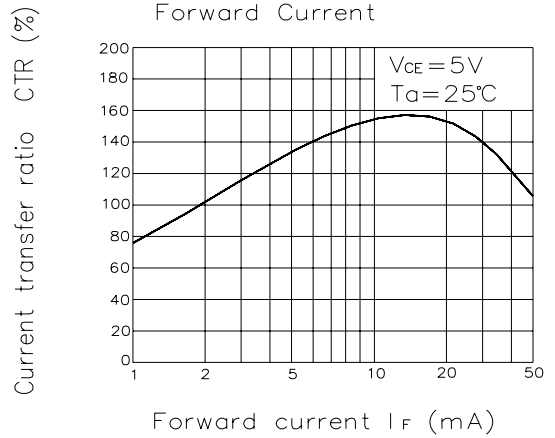

Fig.5 Forward Current vs. Forward Voltage

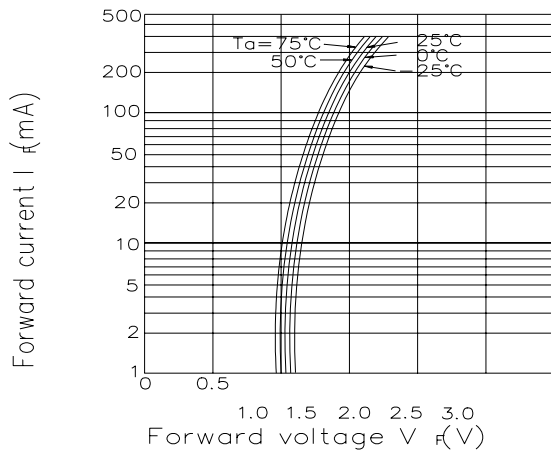

Fig.6

Collector Current vs. Collector-emitter Voltage (Ta=25°C)

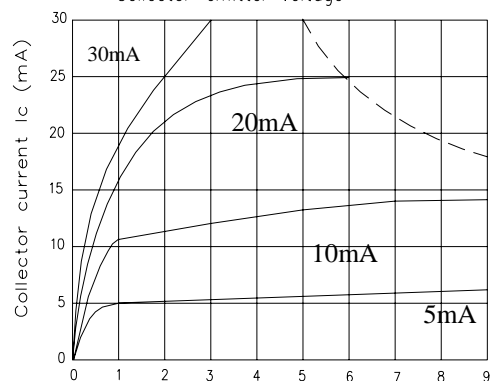

Fig.7

Relative Current Transfer Ratio vs. Ambient Temperature

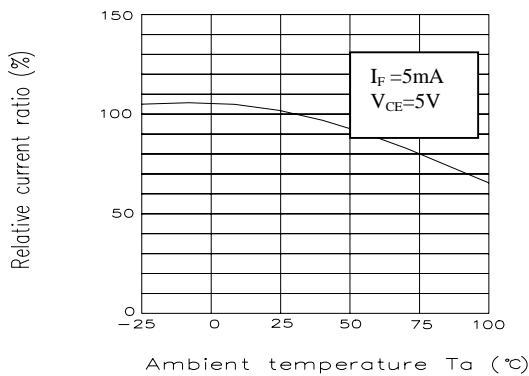
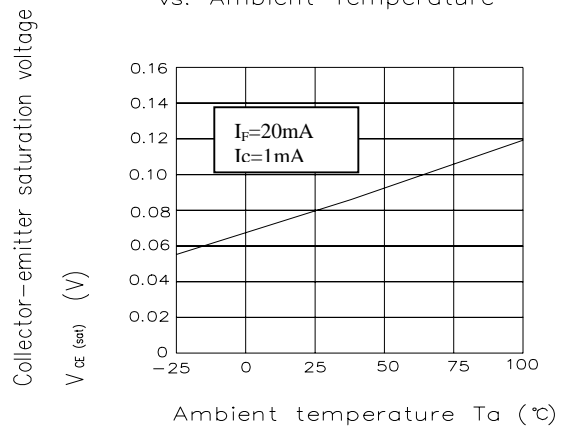

Fig.8

Collector-emitter Saturation Voltage vs. Ambient Temperature



Technical Data Sheet
Photocoupler

EL817 Series

Fig.9 Collector Dark Current vs. Ambient Temperature

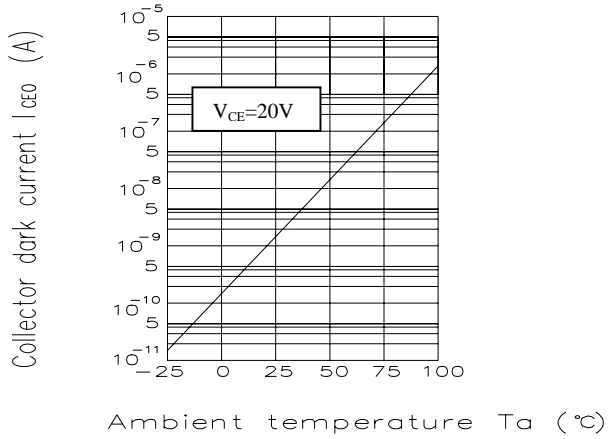

Fig.10 Response Time vs. Load Resistance

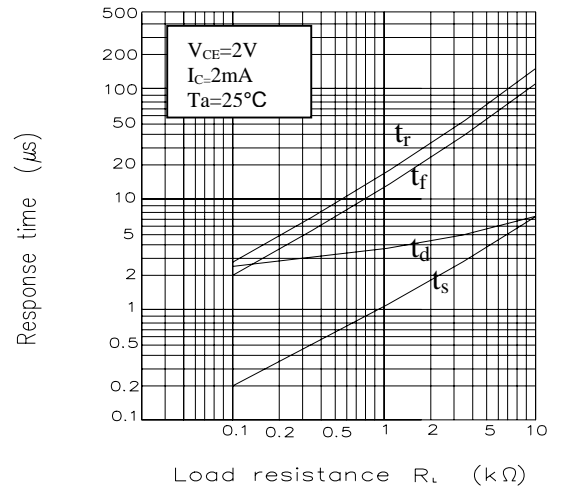
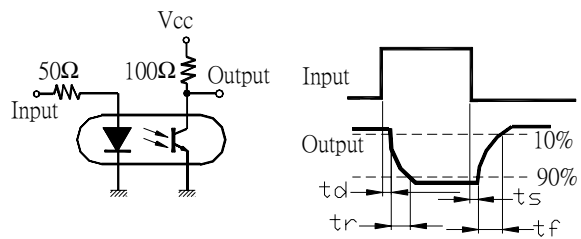
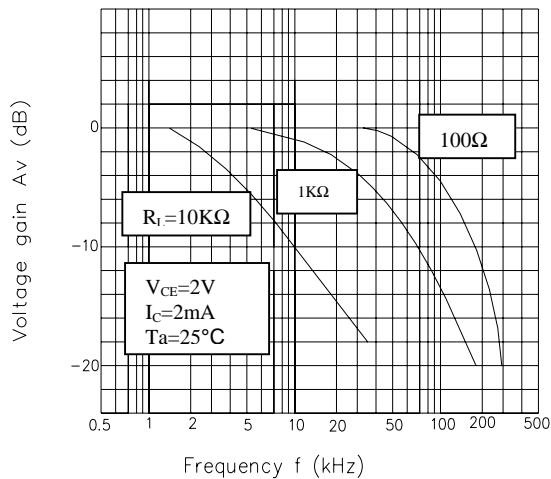

Fig.11 Frequency Response





Technical Data Sheet

Photocoupler

EL817 Series

RELIABILITY PLAN

- The reliability of products shall be satisfied with items listed below.

Confidence level : 90 % , LTPD : 10 %

Classification	Test Item	Description & Condition	(Acc.) Sample	Failure Criteria	Reference Standard
Endurance test	Operation Life *	Ta = 25 ± 3°C IR: If = 50 mA Pt: Pc = 130 mW (Vf=1.4v) , 1000 hrs	0 / 22	CTR shift > 1.2 Vf > U* 1.0 Ir > U * 1.0 Vce(sat) >U*1.0 Bvceo < L*1.0 Bveco < L*1.0 L :Low Spec.Limit U : Up Spec. Limit	MIL-S-750 : 1026 MIL-S-883 : 1005 JIS C 7021 : B-1
	High Temperature / High Humidity Reverse Bias (H3TRB)	Ta = 85 ± 3°C , Humi. = 85 % rh Pt: 80% * Vce (max rating) , 1000 hrs	0 / 22		JIS C 7021 : B-11
	High Temperature Reverse Bias (HTRB)	Ta = 105 ± 3°C Pt: 100% * Vce (Max rating) , 1000 hrs	0 / 22		JIS C 7021 : B-8
	Low Temperature Storage	Ta = -50 ± 3°C , 1000 hrs	0 / 22		JIS C 7021 : B-12
	High Temperature Storage	Ta = 125 ± 3°C , 1000 hrs	0 / 22		JIS C 7021 : B-10 MIL-S-883 : 1008
	Auto clamp	P = 15 PSIG , Ta = 121 °C , Humi. = 100 % rh , 48 hrs	0 / 22		JESD 22-A102-B
Environmental Test	Temperature Cycling (Air to Air)	125°C ~ - 55 °C 30 ~ 30 min , 100 cycles	0 / 22	MIL-S-883 :1010 JIS C 7021 : A-4	
	Thermal Shock (Liquid to Liquid)	125 ~ - 55°C t (dwell) = 5 min t (trans.) = 10 sec , 100 cycles	0 / 22	MIL-S-202 : 107D MIL-S-750 : 1051 MIL-S-883 :1011	
	Solder Resistance	Ta = 260 ± 3°C t (dwell) = 10 ± 1 sec	0 / 22	MIL-S-750 : 2031 JIS C 7021 : A-1	
	Solder Ability	Ta = 230 ± 3 °C t (dwell) = 5 ± 1 sec	0 / 22	MIL-S-883 : 2003 JIS C 7021 : A-2	

Technical Data Sheet Photocoupler

EL817 Series

1. Tube Packing Specifications (For Dip & M Type)

1. Tube

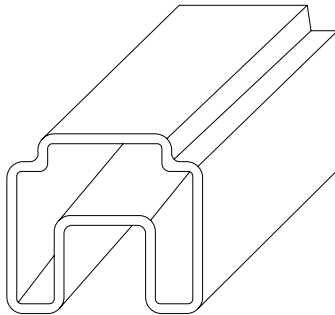

2. Inner Carton

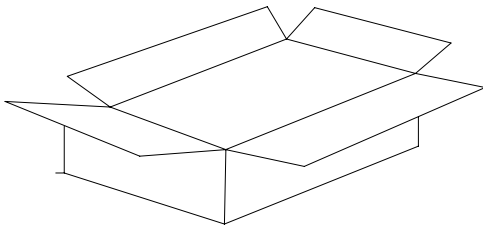

3. Outside Carton

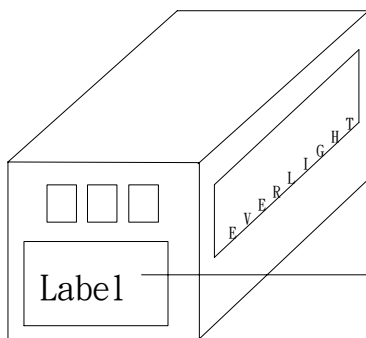

EVERLIGHT

CPN:

P/N:



EL817

QTY:



CAT:

HUE:

REF:

LOT NO:

MADE IN TAIWAN



● Packing Quantity

1. 100 Pcs/ Per Tube
2. 25 Tubes / Inner Carton
3. 12 Inner Cartons / Outside Carton

**Technical Data Sheet
Photocoupler**

EL817 Series

1. Tape & Reel Packing Specifications

1. Tape & Reel (For S Type only)

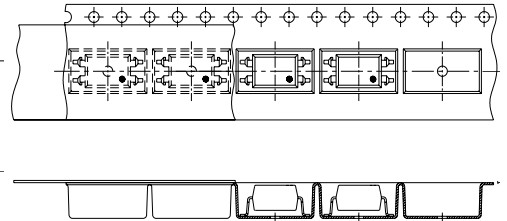
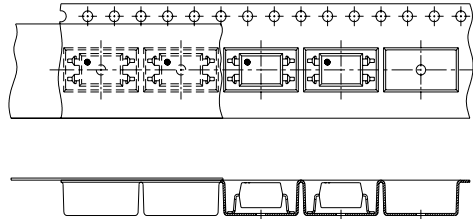
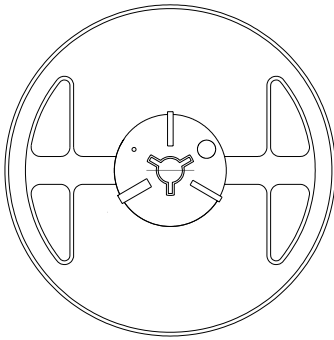

TA

TB



2. Inner Carton

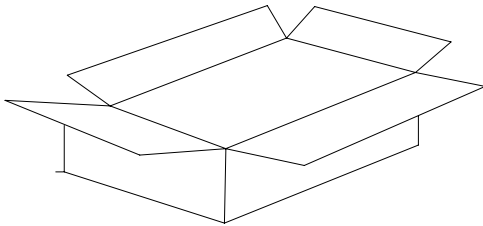

3. Outside Carton

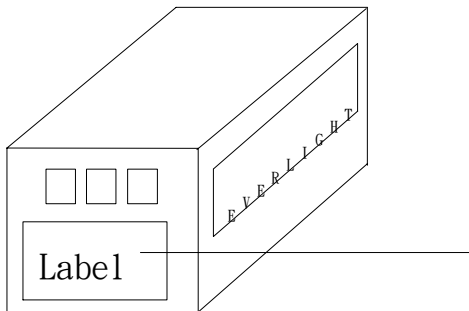

EVERLIGHT

CPN:

P/N:



EL817

QTY:



CAT:

HUE:

REF:

LOT NO:

MADE IN TAIWAN



● Packing Quantity

1. 1,000 Pcs / Per Reel
2. 3 Reels / Inner Carton
3. 10 Inner Cartons / Outside Carton